

## ARIVA 80CM PENDANT LIGHT

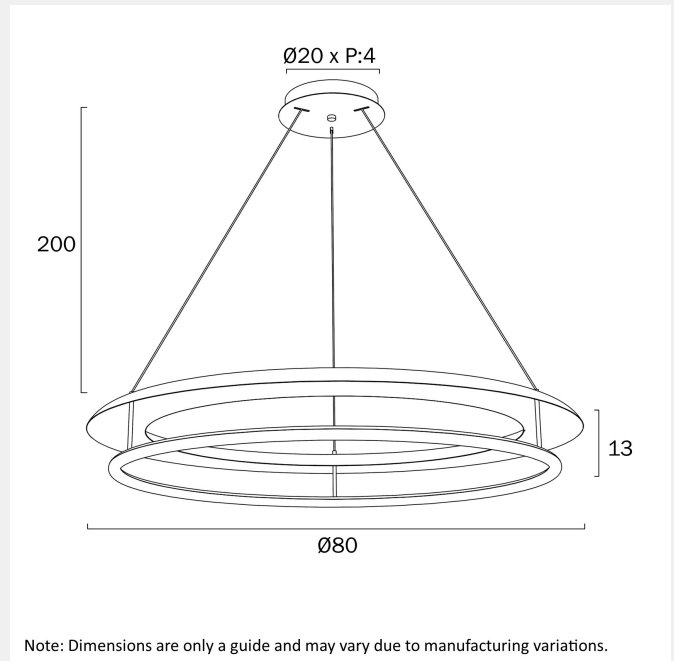

### LIGHT SOURCE

**Voltage Input**

240V

**Total Wattage (max)**

46

**Globe Type**

LED integrated SMD

**Globe / Light Source qty**

1

**Globe / Light Source included**

Yes

**Color Kelvin**

3 CCT (3000k - 4000k - 5000k)

**Color Temperature**

Warm White; Natural White; Cool White

**Dimmable**

Yes - TRIAC

**Lumens**

1525

**CRI (Color Rendering Index)**

>90

**Surge Protection (Yes/No)**

Yes

### SPECIFICATIONS

**Lead and Plug**

No

**IP rating**

IP20

**Suspension Type**

Cable

**Height Adjustable?**

Yes

**Raked Ceiling Compatible**

No

**Mounting**

Surface

**Electrical Protection**

CLASS I - HIGH VOLTAGE, EARTH REQUIRED

### COLOUR AND MATERIAL

**Fixture Material**

Aluminium, Iron, Silicon

**Fixture Finish**

Sand

**Diffuser Material**

Silicone

[ARIVA PE80-WH] ARIVA  
80CM PENDANT LIGHT  
(WHITE)



9329501083468

**WARRANTY**

---

**Replacement Warranty**

\*3 Years

**PRODUCT DIMENSIONS**

---

**Fixture Weight (Kg)**

5.9

**Fixture Diameter (cm)**

80

**Fixture Height (cm)**

13

**Suspension Length (cm)**

200

**OTHER**

---

**Installation Required**

Yes (by Licensed Electrician only)

**CARE**

---

**Care Instructions**

Do not use strong liquid cleaners. Wipe clean with a dry cloth. Aluminium, Brass and Stainless Steel will naturally oxidise and change overtime. Exterior products require regular four (4) monthly cleaning and maintenance to ensure they do not accumulate dirt or other environmental deposits. Wipe the product with a mild detergent and warm water to remove surface deposits. Rinse with fresh water and wipe dry with a soft cloth. An extra temporary protection barrier of water displacement oil can help to maintain the surface, such as WD40, sprayed onto a soft cloth and rubbed onto the surface.

**VARIANTS**

---

[ARIVA PE80-BK] ARIVA 80CM  
PENDANT LIGHT (BLACK)



9329501083475

Find ARIVA 80CM PENDANT LIGHT on  
[www.telbix.com](http://www.telbix.com)

